

HAS-WM05

単位：mm

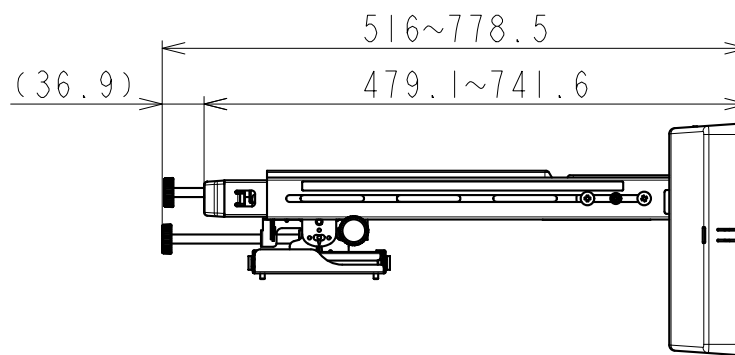
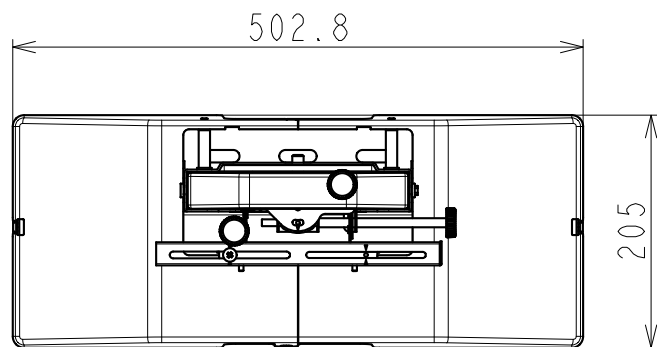
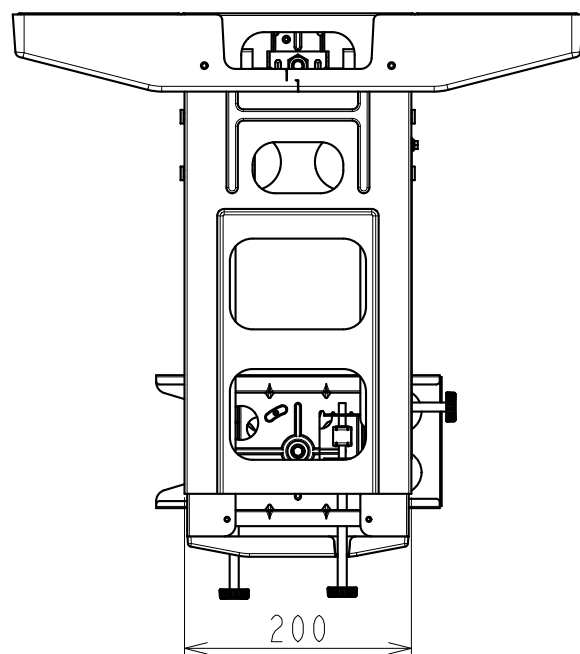

仕様

1. 材質：SPCC

壁側金具板厚 $t=1.6$

2. 表面処理：焼付け塗装

(ライトグレー)(N7)